

# DIMENSIONS

**RT 45**

DIMENSIONS · ABMESSUNGEN · DIMENSIONI · DIMENSIONES ·  
DIMENSÕES · РАЗМЕРЫ

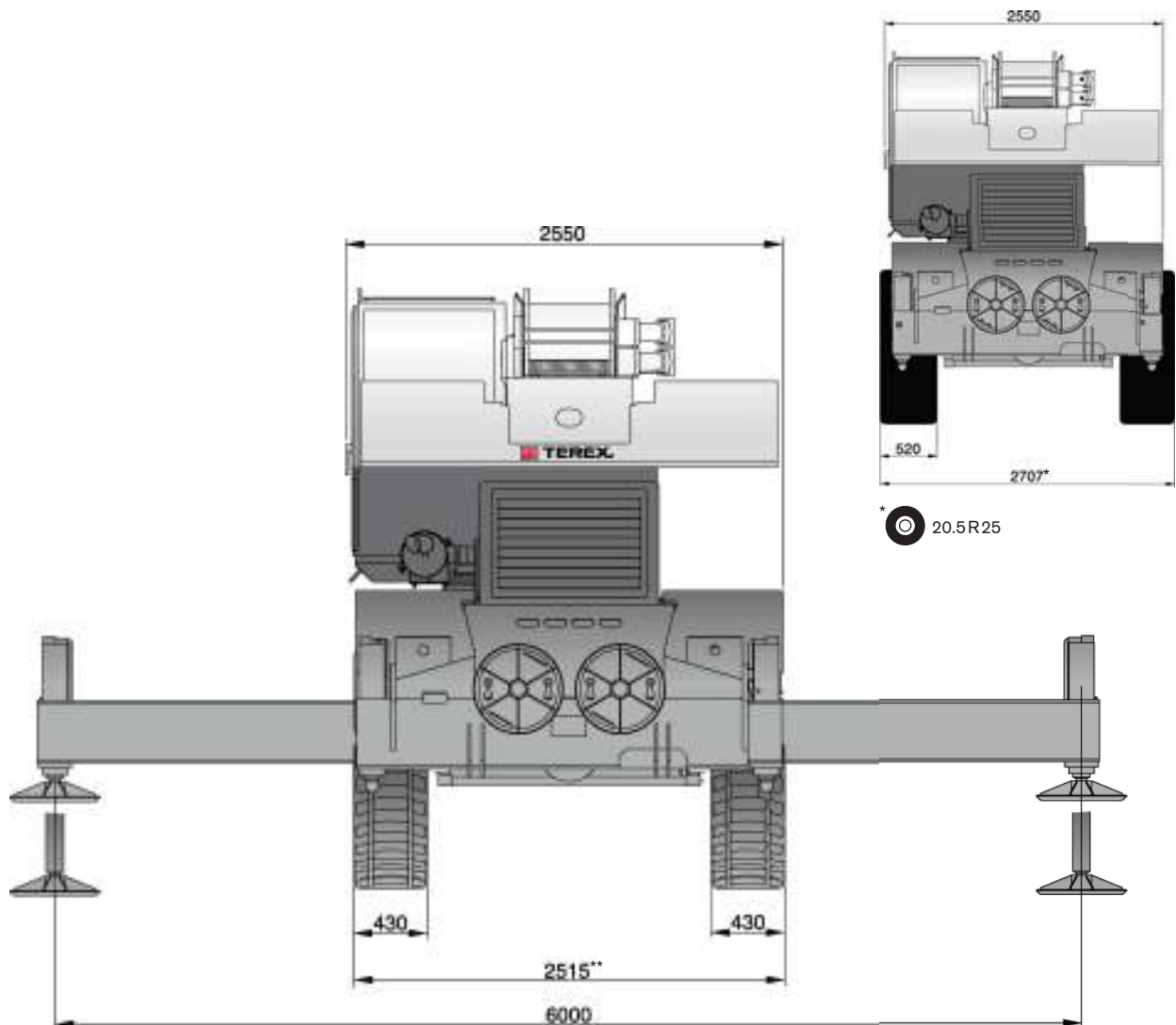

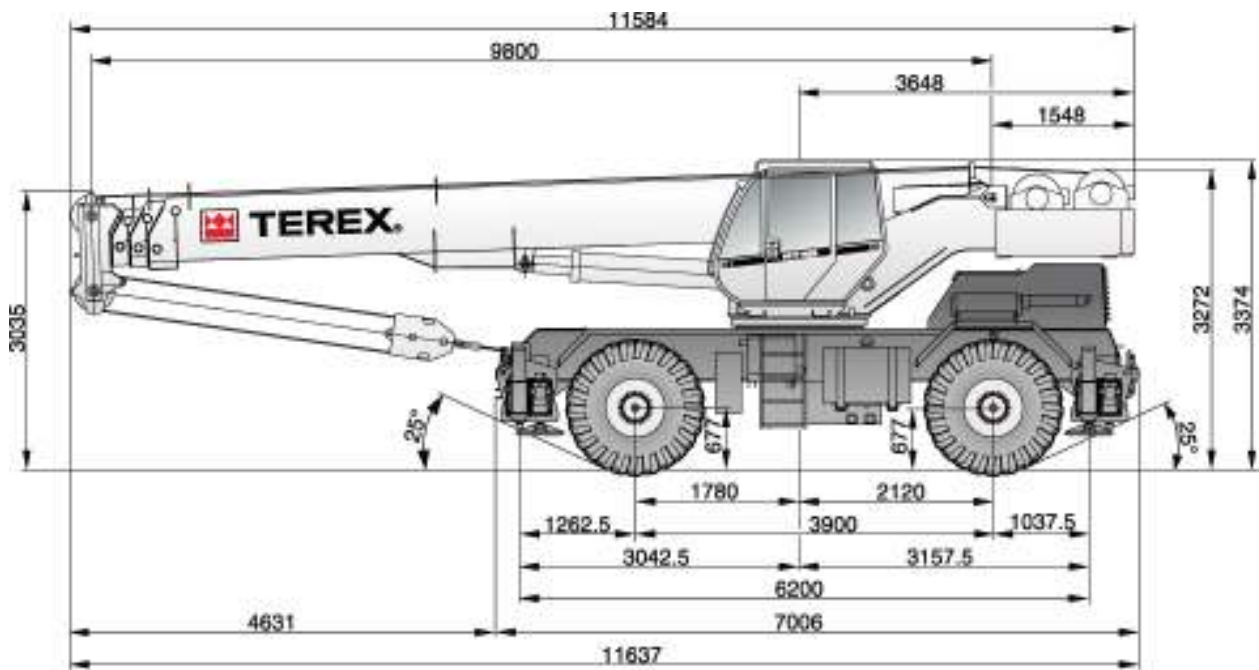







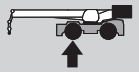

\* 20.5R25

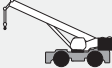
\*\* 16.00R25

# WEIGHTS

RT 45

POIDS · GEWICHTE · PESI · PESOS · PESOS · BEC

				
 <b>without hook block</b> · sans crochet moufle · ohne Unterflasche · senza bozzello · sin gancho · sem moitão · п/ Крюкблок		28 000 kg	13 440 kg	14 560 kg
<b>Add / Subtract for main optional equipment · Supplément / retrait de poids pour équipement optionnel · Für optionale Ausstattung hinzufügen / abziehen · Da sommare a seconda dell'allestimento opzionale · Sumar / restar para equipamiento opcional principal · Acrescentar / subtrair para principais equipamentos opcionais · Добавить/вычесть для дополнительного оборудования</b>				
 <b>8 m boxed stowed aside the boom</b> · 8 m caissonnée, escamotable sur le côté de la flèche · 8 m Kastenprofil, seitlich am Ausleger verstaut · scatola 8 m staffata a lato braccio · 8 m tipo cajón almacenado lateralmente a la pluma · 8 m tipo caixa guardada na lateral da lança · 8 m коробчатая, укладываемая сбоку на основной стреле		+ 730 kg		
<b>15 m boxed stowed aside the boom</b> · 15 m caissonnée, escamotable sur le côté de la flèche · 15 m Kastenprofil, seitlich am Ausleger verstaut · scatola 15 m staffata a lato braccio · 15 m tipo cajón almacenado lateralmente a la pluma · 15 m tipo caixa guardada na lateral da lança · 15 m коробчатая, укладываемая сбоку на основной стреле		+ 1 010 kg		
<b>8 m lattice stowed aside the boom</b> · 8 m en treillis escamotable sur le côté de la flèche · 8 m Gittermast, seitlich am Ausleger verstaut · tralicciata 8 m staffata a lato braccio · 8 m tipo celosia almacenado lateralmente a la pluma · 8 m treliçada guardada na lateral da lança · 8 m решетчатая, укладываемая сбоку на основной стреле		+ 840 kg		
 <b>2</b> **		+ 600 kg	- 70 kg	+ 670 kg
 <b>45 t*</b>		+ 400 kg	+ 630 kg	- 230 kg
 <b>35 t*</b>		+ 280 kg	+ 440 kg	- 160 kg
 <b>25 t*</b>		+ 260 kg	+ 410 kg	- 150 kg
 <b>15 t*</b>		+ 194 kg	+ 305 kg	- 110 kg
 <b>10 t*</b>		+ 170 kg	+ 270 kg	- 100 kg
 <b>5 t*</b>		+ 50 kg	+ 80 kg	- 30 kg

**NOTE: Values are subject to 2% variation** · REMARQUE : Les valeurs sont sujettes à une variation de 2% · HINWEIS: Werte können bis zu 2% abweichen ·  
NOTA: I valori possono variare fino al 2% · NOTA: Valores sujetos a una variación del 2% · OBSERVAÇÃO: Valores sujeitos a 2% de variação ·  
ПРИМЕЧАНИЕ. Значения даны с допуском +/- 2%

\* Weight distribution calculated considering the hook block linked to the front shield of the machine · Répartition du poids calculée en considérant le crochet moufle  
connecté au panneau frontal de la machine · Berechnung der Gewichtsverteilung mit Hakenflasche am vorderen Rammschutz des Krans gesichert · Le distribuzioni  
dei pesi sono calcolate considerando il bozzello legato davanti al carro · Distribución de pesos calculada considerando el gancho asegurado al protector frontal ·  
Distribuição de pesos calculada considerando o moitão ligado à proteção dianteira da máquina · Распределение нагрузки рассчитано для крана с крюкблком, за-  
крепленном на переднем щите машины

\*\* Weight includes rope · Le poids comprend le câble · Gewicht einschließlich Seile · I pesi includono la fune · El peso incluye soporte cabrestante · Peso inclui cabo ·  
Вес включает вес троса